

# 1080P FULL HD Baby Monitor

## User Manual

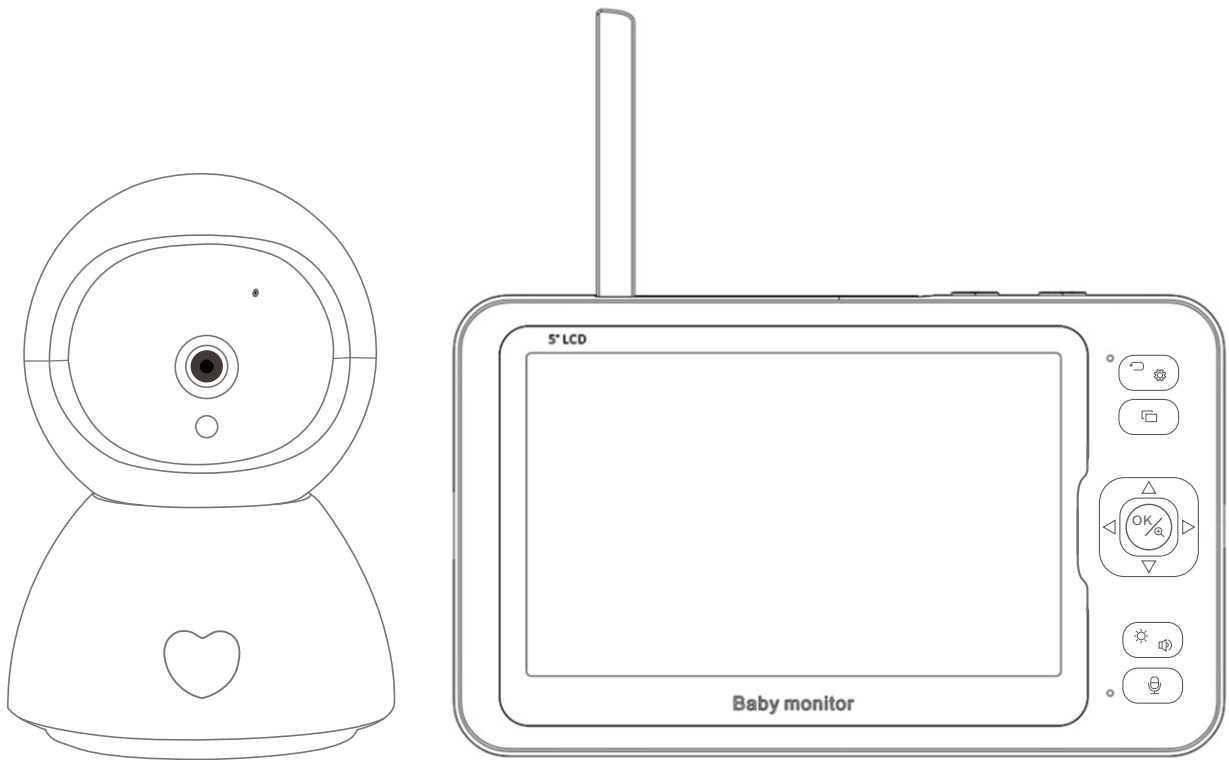

# 1.What' s Included:

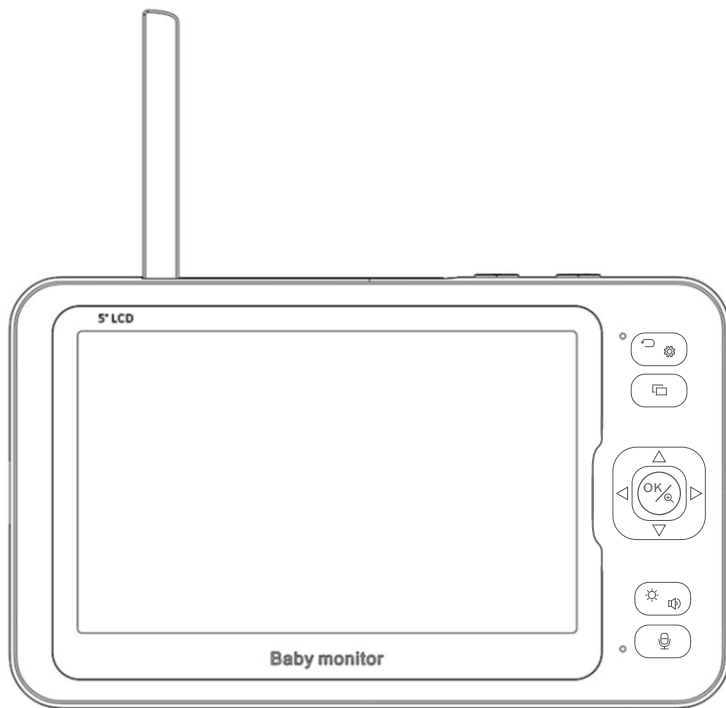

×1

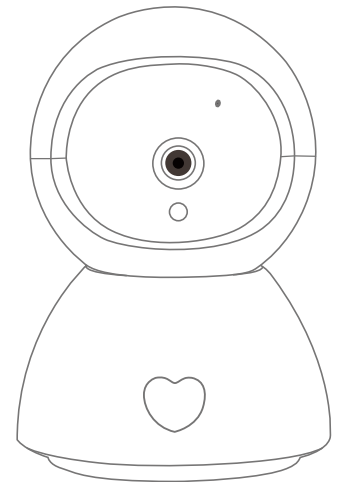

×1

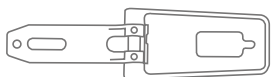

×1



×2

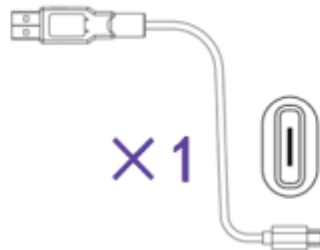

×1

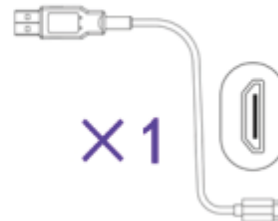

×1



×1

- 1.1: Camera\*1
- 1.2: LCD Monitor\*1
- 1.3: Mounting Bracket\*1
- 1.4: Power Adaptor\*2
- 1.5: Type-C Cable\*1
- 1.6: Micro USB Cable\*1
- 1.7: Screws\*1
- 1.8: User Manual\*1

## 2.Key and Interface Introduction

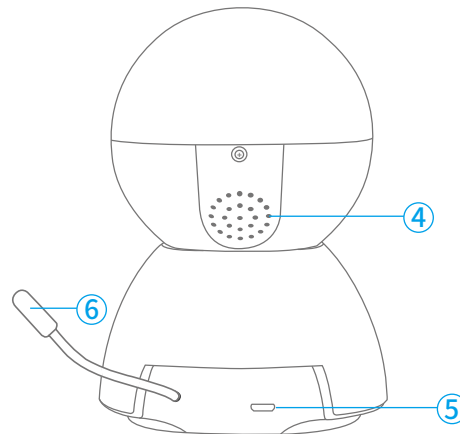
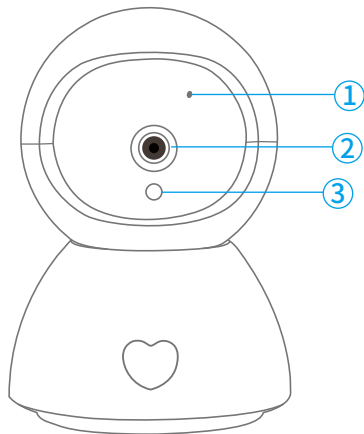

- 1.Microphone
- 2.Lens
- 3.Photoresistance
- 4.Speaker
- 5.Power Port
- 6.Digital Temp Sensor

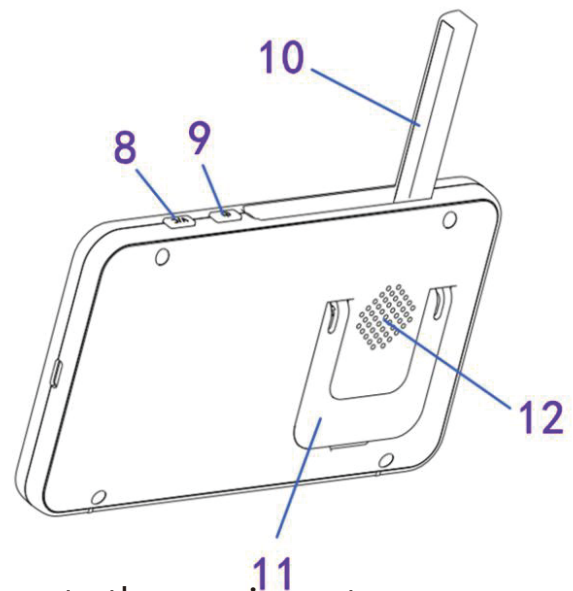
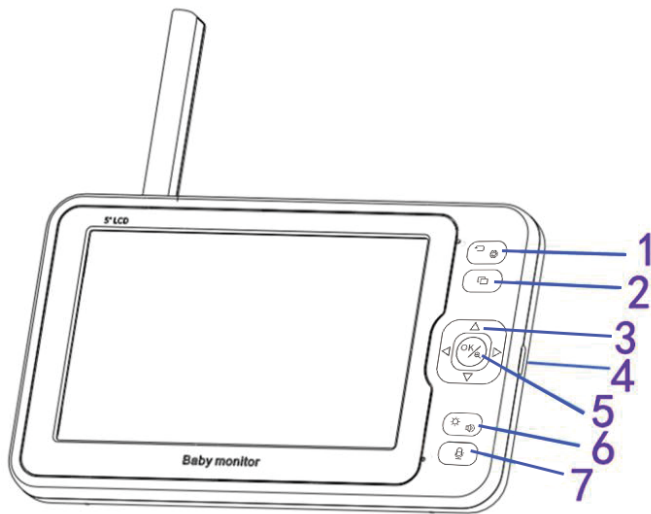

2.1: Back button: ①Press the button to return to the previous step, press again to enter the setting

②In the main menu, press the button to return to the previous menu

2.2: Camera Switch Button: Press the button to switch camera from one to the next .

2.3: Direction Button: ①In Monitoring Mode the button could control the Pan and Tilt of the camera.

②In main menu the button could select direction.

2.4: Type-C Charge Port.

2.5: OK button: ①Press the to enter menu and confirm on settings .



②Click this button under the monitoring screen to enlarge the screen

2.6: Brightness and volume buttons:①Press the up and down arrow keys to adjust the brightness

②Press the left and right arrow keys on the button to adjust the volume

2.7: Talk Button: Press to talk while live audio off, press again to turn on live

audiowhile talk function stop.

- 2.8: Sound Detection (VOX) Button: Press to open sound detection (On the display will show  ) Press again to turn off sound detection(On the display  will disappear)
- 2.9: Power On/Off Button: Long press to turn on/off the unit ,short press to enter standby mode.
- 2.10: External Antenna: Put the antenna up the signal will reach the best state.
- 2.11: Bracket
- 2.12: Speaker

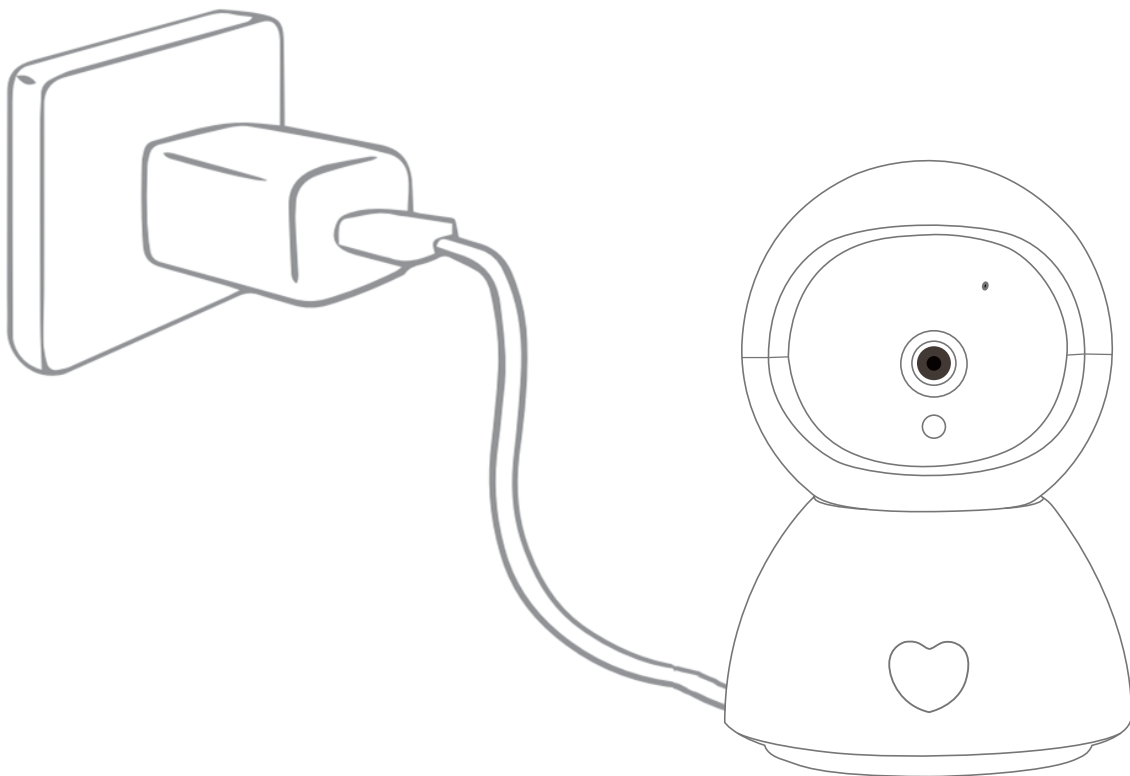

## 3. Connect the camera to the Monitor

- 3.1: Power on the camera about 3-5 s the camera will say “power on system starting up” and start to work.
- 3.2: Long Press the power on/off button to turn on the unit. (Tips: Kindly make sure the monitor is fully charged before connection when use for the first time)
- 3.3: After camera and monitor ready wait about 10S the picture will show on the monitor then could start to use the baby monitor .

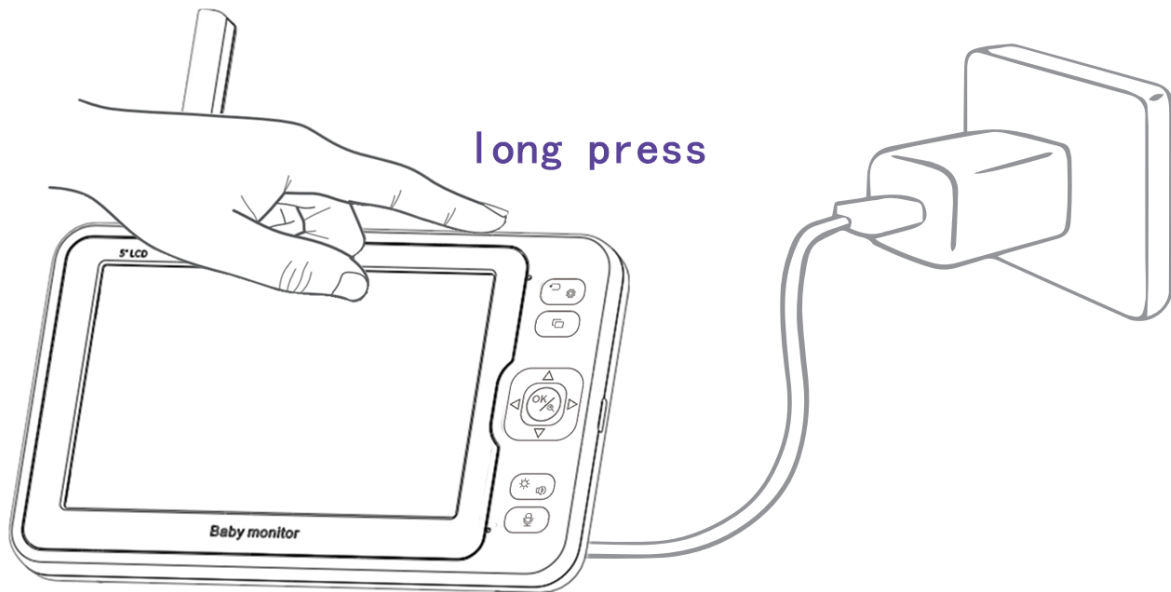



## 4. Add new camera

- 4.1: Enter the main menu and choose camera (  ) → choose channel → Double press OK button to start matching → Configuring (Pic 1) → Connected (Pic 2)
- 4.2: If can't add the camera successfully please check if the camera is powered. If camera already been powered then please reset the camera and add the camera again according to step 4.1.
- 4.3: If need to connect 4 cameras then add from CH1 to CH4. Choose the channel when add cameras to the related channel. Move to the channel you want to view and press OK to switch the channel view. In preview left corner will show the channel now displaying. (  )

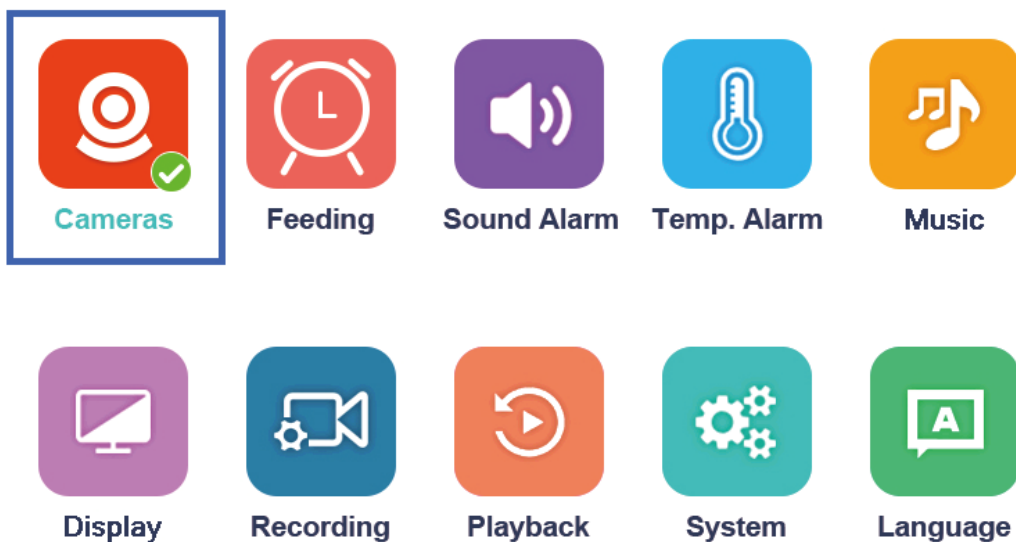



**Configuring**



**Connected(192.168.66.6)**

## 5.Feed Timer Setting

- 5.1: Enter the menu to set up Feed timer(  )---up and down to select time left and right choose single time/ recycle/turn on or off the clock.
- 5.2: After set the feed timer you can choose single time or recycle.
- 5.3: If you don't need feed timer function please close the clock.

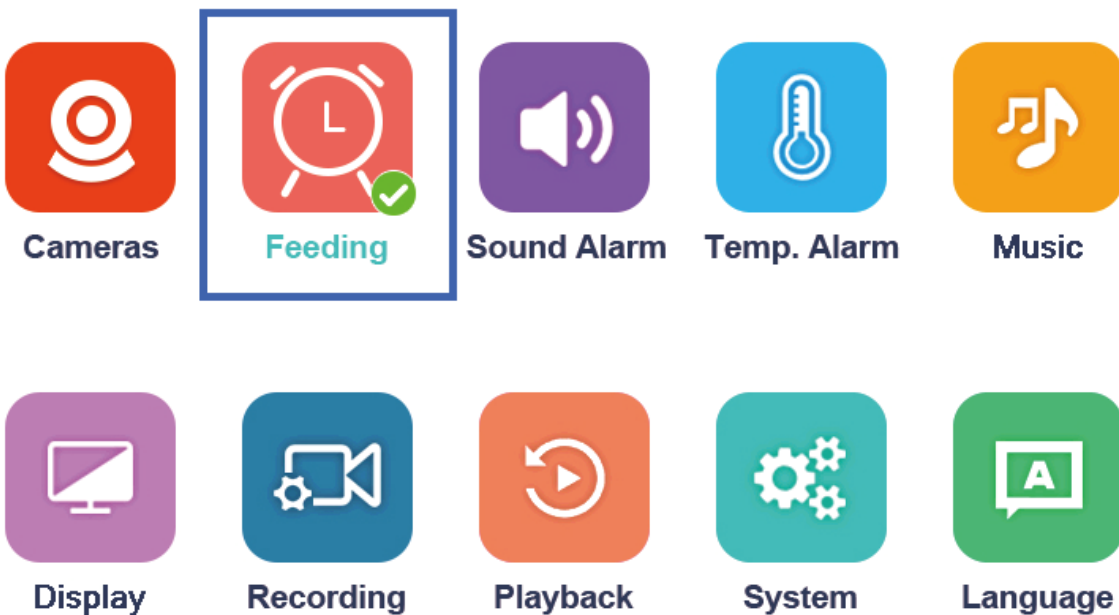

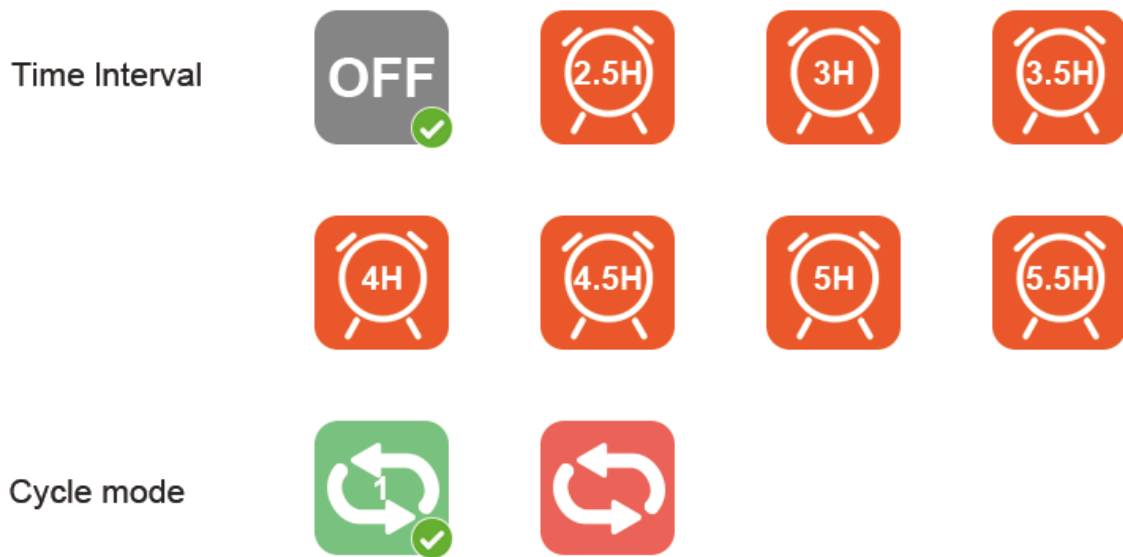

## 6. Sound Detection

- 6.1: Press OK button to enter the main menu and choose Sound detection ( ) There are low/medium/high/optional.
- 6.2: Press VOX button on the top will turn on press again to turn off.
- 6.3: When the camera detected the DB range over the settings the LCD screen will lighten up and show the icon in the middle of the screen. There will be an alarm sound like di di about 30S, if the camera keep detected sound over settings it will send alarm sound continuously. Press any button on the monitor to stop the sound alarm.

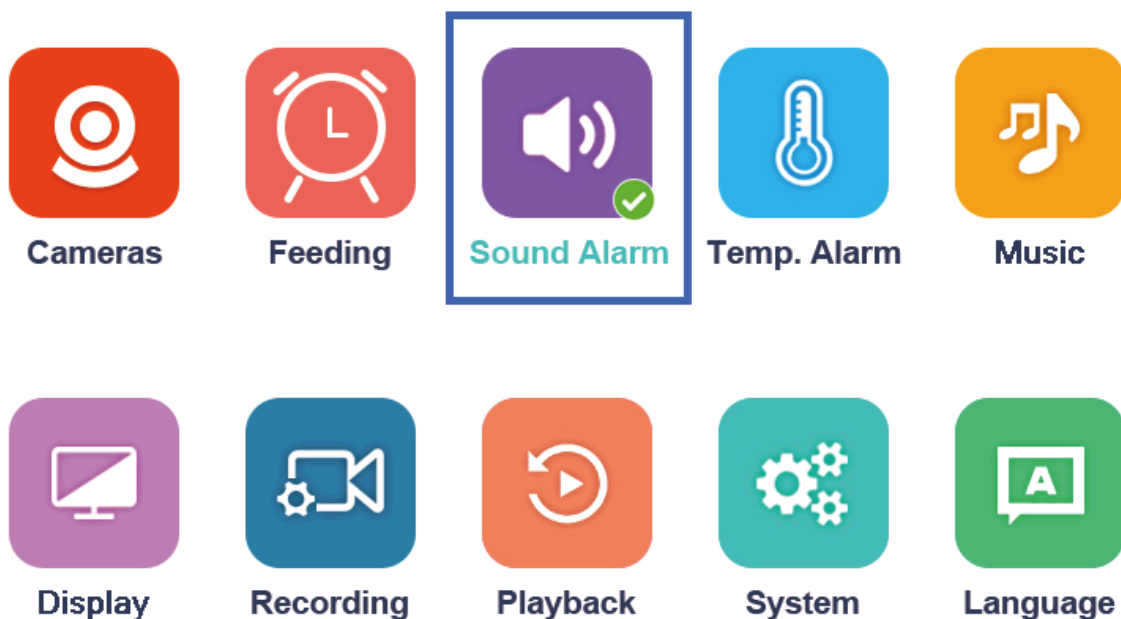



Tips:

Set sensitivity for sound detection.

1. LOW: the alarm threshold is a shouting cry.
2. MEDIUM: the alarm threshold is a loud voice.
3. HIGH: the alarm threshold is normal speech.

## 7. Temperature Detection Alarm

7.1: Temperature alarm setting could be (°C) or (°F) according to actual usage.

7.2: The default temperature is 18-30°C once the temperature lower or higher than the range will send alarm

7.3: The temperature alarm need to be shut down manually if it keep alarm due to temperature issue.



Cameras



Feeding



Sound Alarm

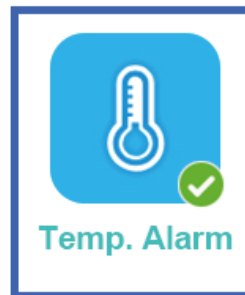

Temp. Alarm



Music



Display



Recording



Playback



System



Language

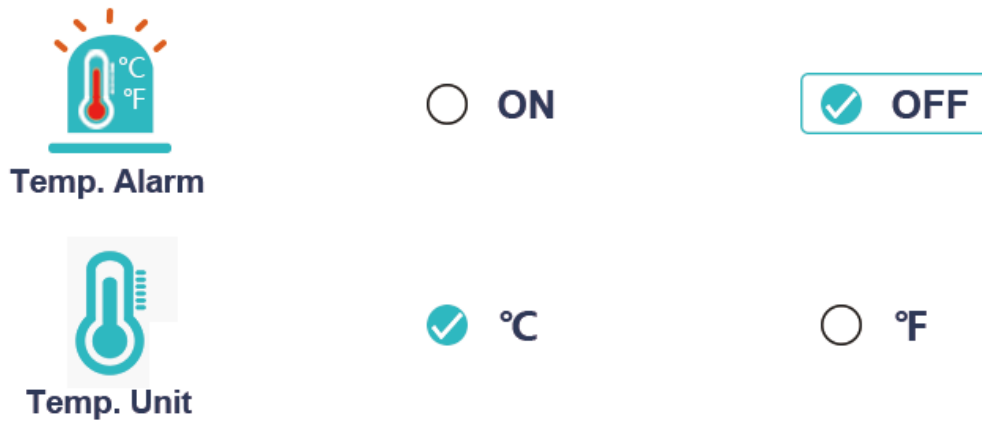

Note: The normal temperature range is 18-30 degrees Celsius.

## 8. Play the lullaby

8.1: Enter the main menu and choose the lullaby icon (  ) could select No.1-No.6 lullabies. During the play the lullaby the information will show on the left corner of the screen.

8.2: Name of the lullaby:

- ① Castle in the Sky
- ② Grave of the Fireflies
- ③ Passive
- ④ Spirited Away
- ⑤ Street of sea
- ⑥ The Love That Transcends Time

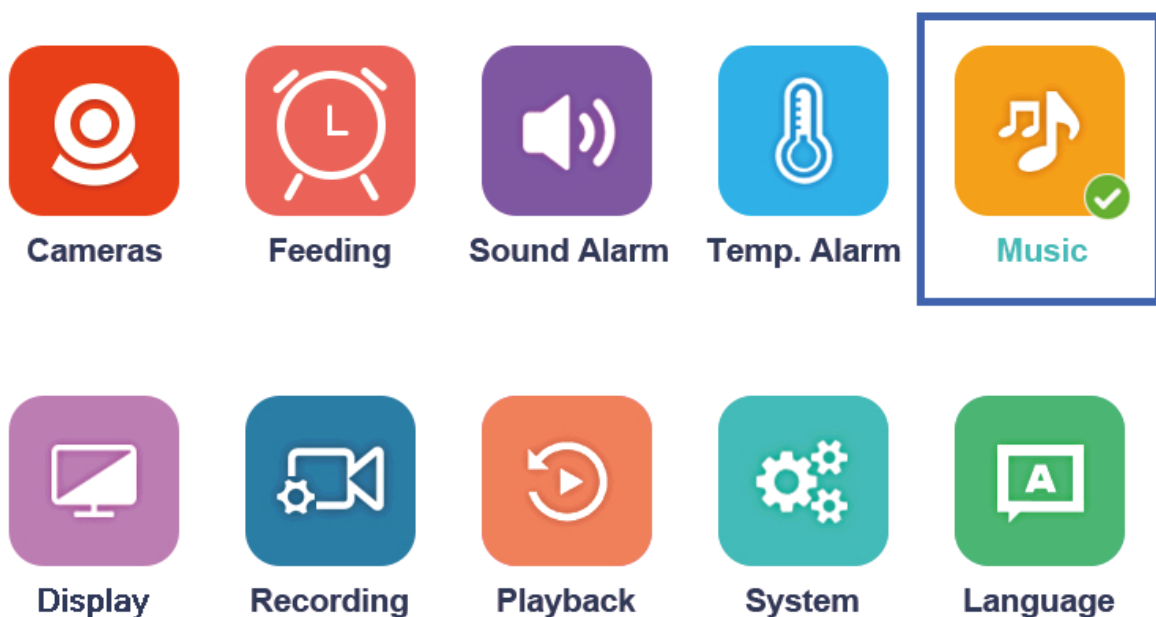

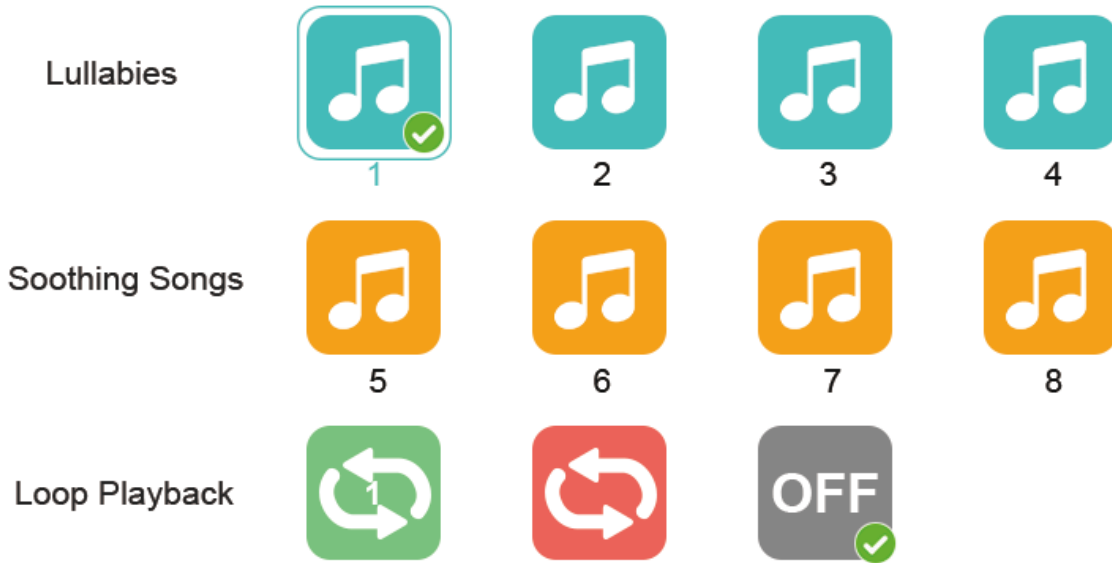

## 9. Display Settings

9.1: The display settings have Dormant/ LUMI

9.2: Dormant mode default 1Min(  )/10Min(  )/30Mini(  )  
/ALWAYS ON (  ) could adjust according to actual usage.

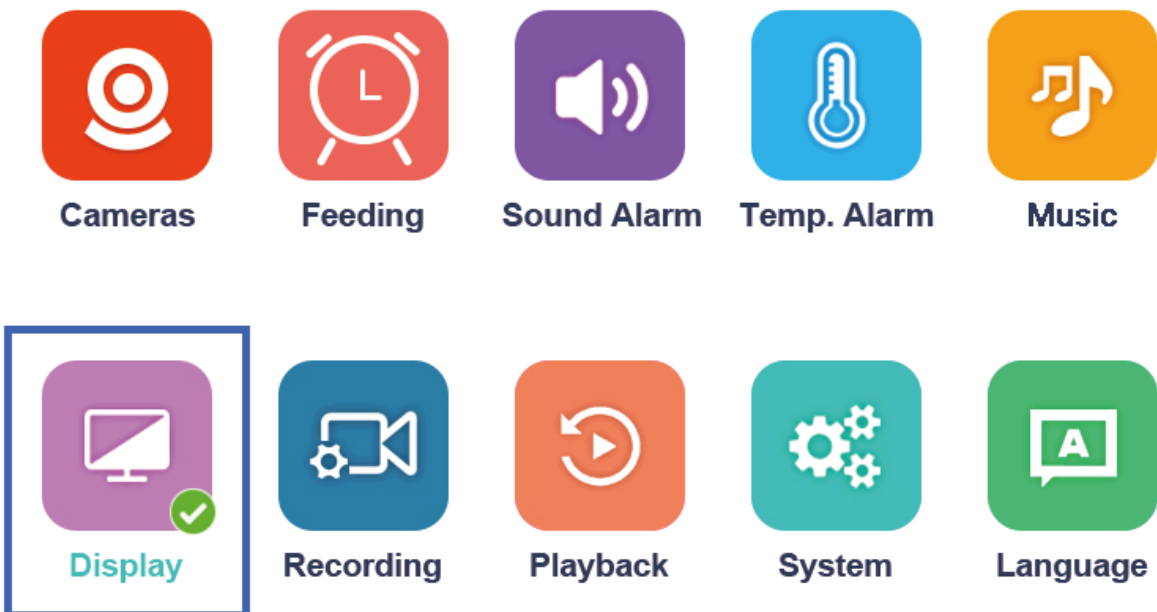

Dormant

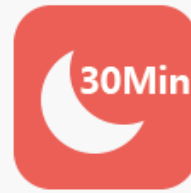

## 10. Video Recording

10.1: Enter the main menu and select the record icon (  ) The record file can choose 0.5Hr/1Hr/2Hr (Means how long to pack to one file)

12.2: If don' t need to record could choose OFF.



Cameras



Feeding



Sound Alarm



Temp. Alarm



Music



Display

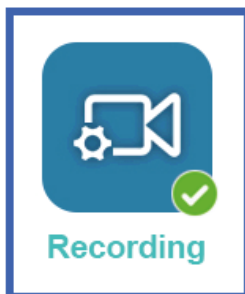

Recording



Playback



System



Language

Record by Monitor

Resolution: 480P



Record by Camera

Resolution: 1080P

Channel1



Channel2





Channel3



Channel4



# 11.Video Playback

11.1: Enter the menu and select the playback icon (  ) and click  to pick up the time of the video you want to play.

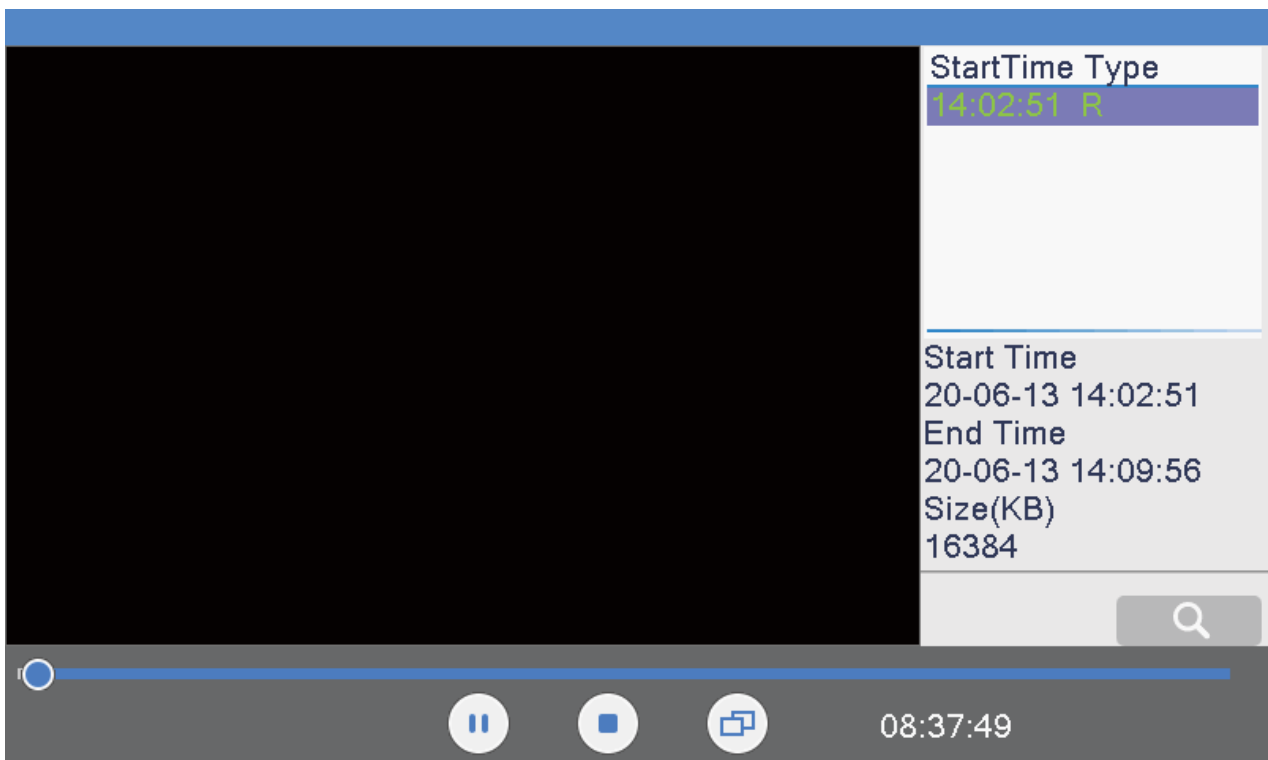
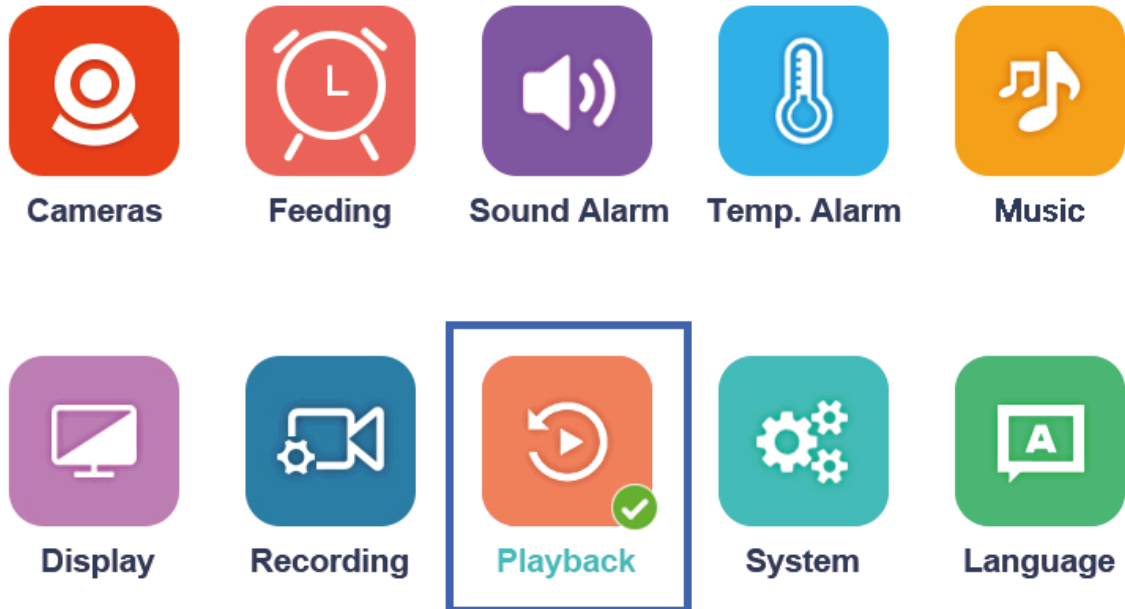

# 12. System Settings

12.1: Time & Date (  ) setting: System Time/Date Format/Separator/  
Time Format could set according to actual usage

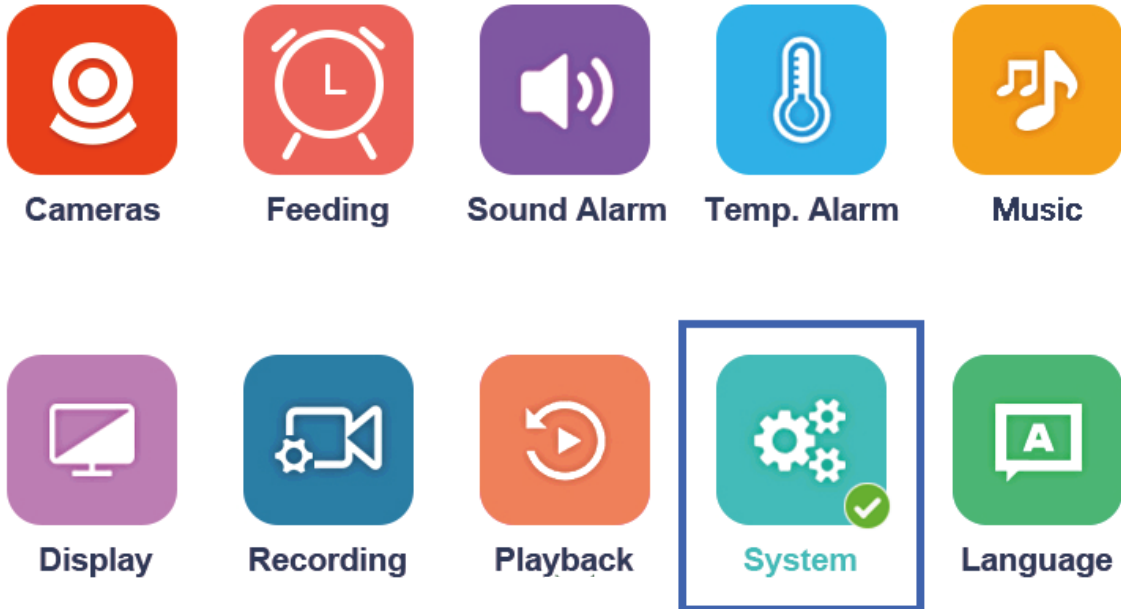

Date: 2020 : 11 : 23

Time: 14 : 21 : 50

Time Format:

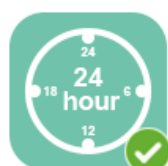

Cancel

OK

12.2: Back to factory settings(  ). Not suggest to use normally please contact the seller for assistant if have to.

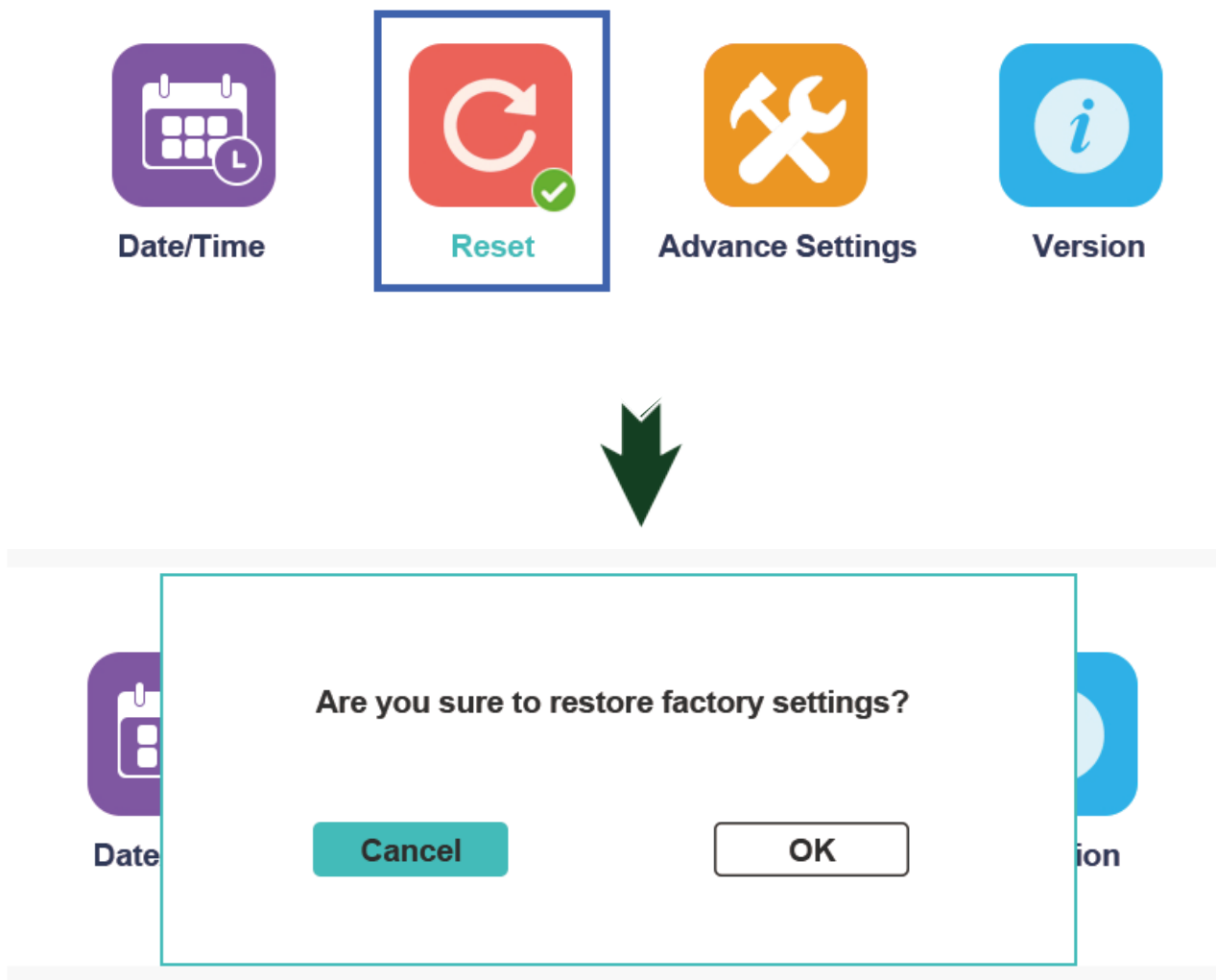

12.3: Advance Settings(  ): You can set the screen rotation, check storage capacity and remaining capacity

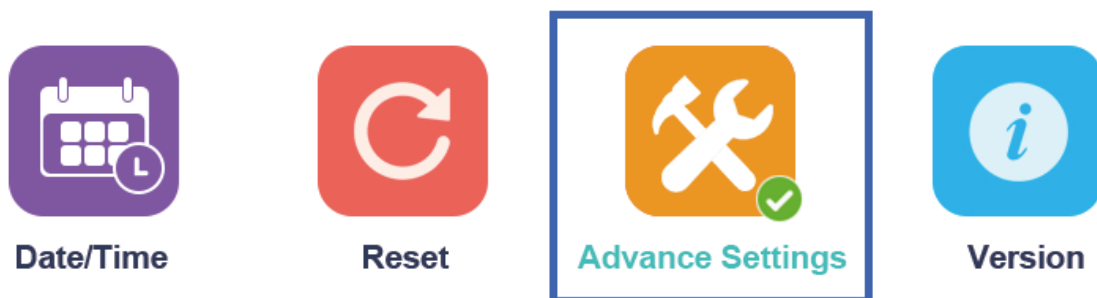



	Capacity	Available	Picture Filp	
Monitor	/	/		
Channel1	/	/	<input type="button" value="OFF"/>	<input type="button" value="ON"/>
Channel2	/	/	<input type="button" value="OFF"/>	<input type="button" value="ON"/>
Channel3	/	/	<input type="button" value="OFF"/>	<input type="button" value="ON"/>
Channel4	/	/	<input type="button" value="OFF"/>	<input type="button" value="ON"/>

## 12.4: Version Information( )

The version information subject to the actual situation



Date/Time



Reset



Advance Settings

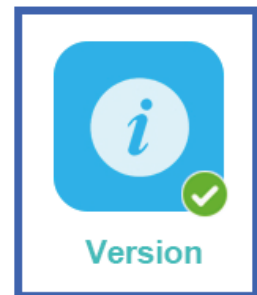

Version



Version XM530\_BMS50X20-WVGA\_16M\_20201123

Release Date 2020-11-23

Serial Number e2ac272798e4b3e4

Channel 01

Version

Release Date

Serial Number

# 13. Language Settings

13.1: The device support 8 language

ENGLISH//JAPANESE/CHINESE/PORTUGUESE/ITALIAN/FRENCH/SPANISH/  
GERMANY default is ENGLISH

13.2: Could adjust the language according to your request. After confirm the language please power off the monitor and restart .When connect the camera it will change to the language same as the monitor .

Tips: When changing the language please make sure the camera is powered on.



**Cameras**



**Feeding**



**Sound Alarm**



**Temp. Alarm**



**Music**



**Display**



**Recording**



**Playback**



**System**



**Language**



## 14. Installation Steps

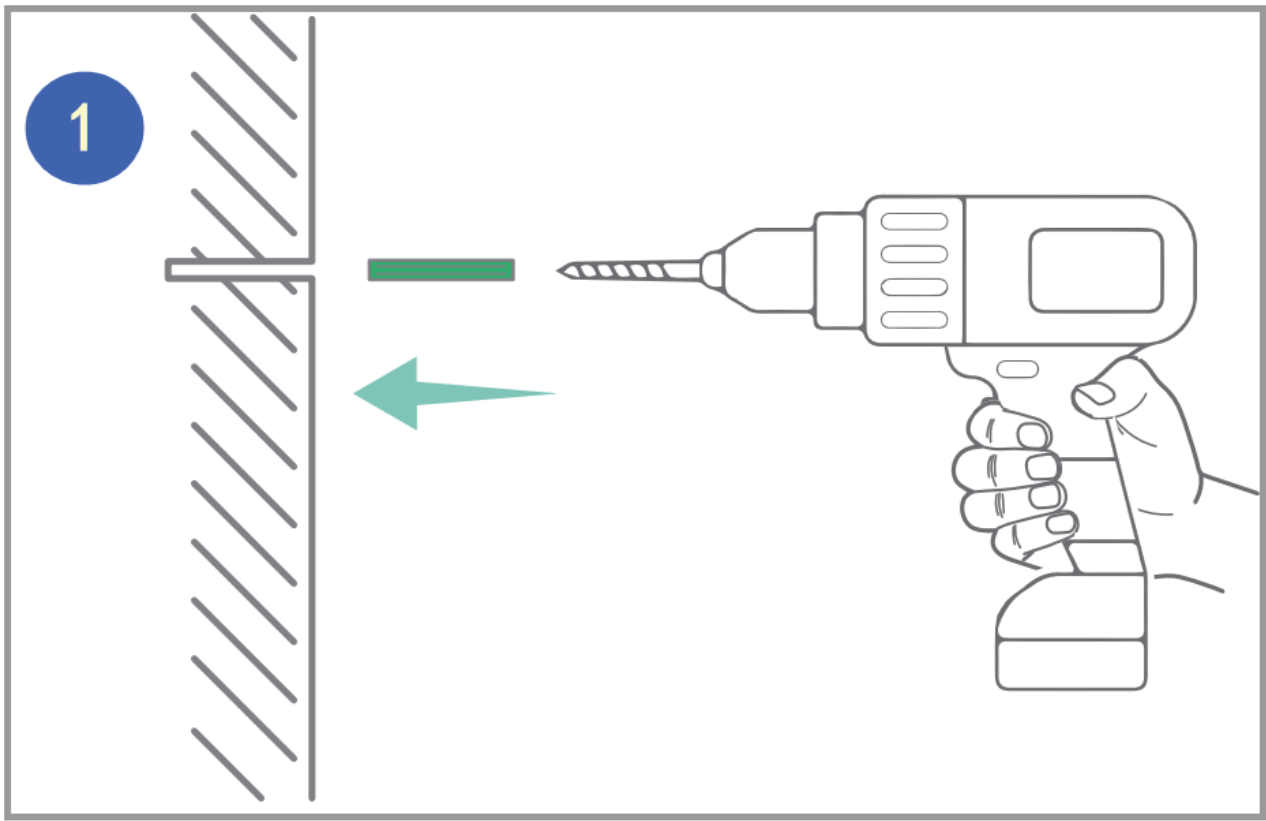

2

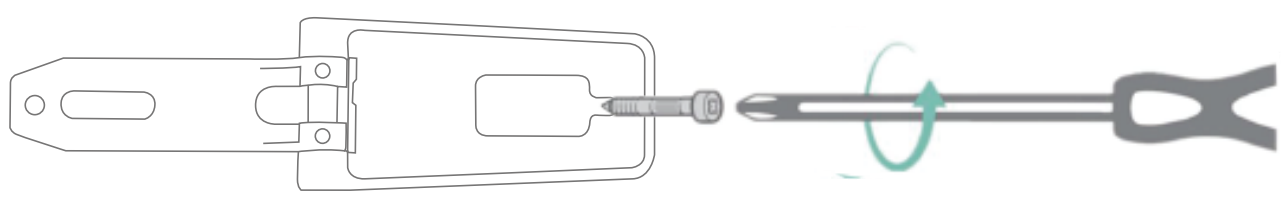

3

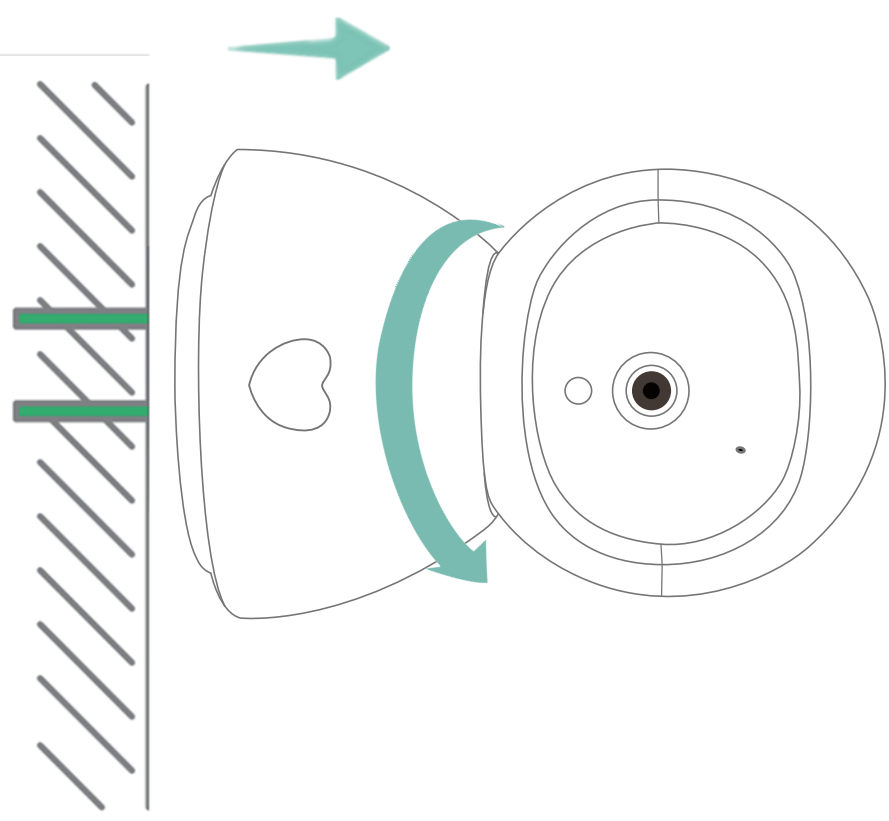

## Questions and Answers:

**Q:** The LCD monitor didn't show the camera ?

**A:** ①Please check if the camera is powered on .

②If camera is powered on please reset the camera to factory settings and add the camera according to steps 4.1.

**Q:** There is annoying sound when use the talk function in near distance?

**A:** When the camera and monitor is within 2meter distance there might be some noise which is a normal Physical phenomena. You can adjust the monitor volume down or keep the camera and monitor from longer distance.

**Q:**The monitor battery drains fast?

**A:**①If you don't open the Dormant mode and the monitor will works all the time so the battery will run faster. Suggest to use Dormant mode with 30S or 60S to save battery.

②The brightness of the monitor maybe too much high could lower down the brightness to expand the standby time.

**Q:**The transfer distance between the camera and monitor not far?

**A:** In an open environment the camera and monitor could transfer as far as 300meters .While for indoor use in case of interference the transfer distance will be influenced like too many walls and wireless electronic devices .

## After-sales instructions:

- 1.Please refer to the actual product all the instructions are for reference only.
- 2.Product may updates in future without notice .
- 3.The manual contains the introduction of the basic functions of the product please operate by yourself.
- 4.If there is any problem when using the product please contact the supplier in time.
- 5.We have tried our best to ensure the completeness and accuracy of the content in the manual, but some data may still be stored with the actual products.In case of deviation, if you have any questions or disputes, please refer to the company's final explanation.
- 6.In cases of any losses caused by wrong operation will be borne by yourselves.